

Next

A product by
Rancilio Group

NEXT

YOUR NEXT
COFFEE
IS NOT
THAT FAR

The logo for EGRO, featuring a red upward-pointing triangle above the word "EGRO" in white, bold, uppercase letters.

EGRO

ENGLISH





YOUR NEXT COFFEE IS NOT THAT FAR.

Egro Next is the new frontier in fully automatic coffee machines. Featuring stylish ergonomic design, Egro Next is intuitive, easy to use and to clean. It guarantees top-quality results for all types of coffee, milk and powder-based drinks. Recommended for locations with an average daily consumption of 300 coffee cups, Egro Next has been designed mainly for use in hotels, offices, fast-food restaurants, convenience stores, service stations, cafés and self-service facilities, and is available in 3 versions: Pure Coffee, Quick Milk, and NMS+.

PURE COFFEE
& QUICK MILK

x250

CUPS PER DAY

NMS+

x300

CUPS PER DAY

HIGHLIGHTS



1

COFFEE

Swiss Coffee Technology

Top-quality results at every cup, thanks to a stainless steel brewing group equipped with Self-Adjusting Grinder technology and separate boilers for coffee and steam.

3

INTERFACE

10" HD Touchscreen

Swipe, tap and scroll with ease through the menu. It's as easy as using your smartphone, with all preferences and drink selections at your fingertips.

Easy Switch

Customise different menus and easily switch between self-service mode for breakfast and barista mode for lunch or dinner.

5

ADD-ON

Total flexibility for every business

Modular portfolio, flexibility, add-ons, fridges, optional features and payment systems to create a bespoke setup for every instance.

2

INNOVATIVE MILK SYSTEM

NMS+

Adjust the frothing level and milk temperature for each beverage. And with the NMS+ version, you can personalise every recipe with cold milk foam thanks to the CMF system.

4

DESIGN

Built to last

Stainless steel brewing group and high-value components come together in a robust design for high performance and maximum durability.

6

CLEANING

Easy to clean

Daily cleaning program and rinsing cycles.

SWISS COFFEE TECHNOLOGY



STAINLESS STEEL BREWING UNIT

The stainless steel brewing unit is available in two brewing chambers with different capacities, either 18 g or 22 g. (optional). The latter version allows you to prepare extralarge American coffees in a single brewing cycle.

STAINLESS STEEL FLAT BURRS

High-precision grinders are equipped with titanium coated stainless steel burrs to provide consistent coarseness for top-quality espresso brewing.

54mm

BURRS DIAMETER

DUAL BOILER TECHNOLOGY

Two separate boilers for coffee preparation and steam.

0.5 l

/16.9 oz

COFFEE BOILER CAPACITY

1.9 l

/64.2 oz

STEAM BOILER CAPACITY

E SELF-ADJUSTING GRINDER (SAG)

The Self-Adjusting Grinder (SAG) can correct any in-cup quality alterations in real time, ensuring coffee consistency in every cup.

2x

1.3 kg/2.9 lb

COFFEE BEAN HOPPER CAPACITY

● Egro Patented Technology

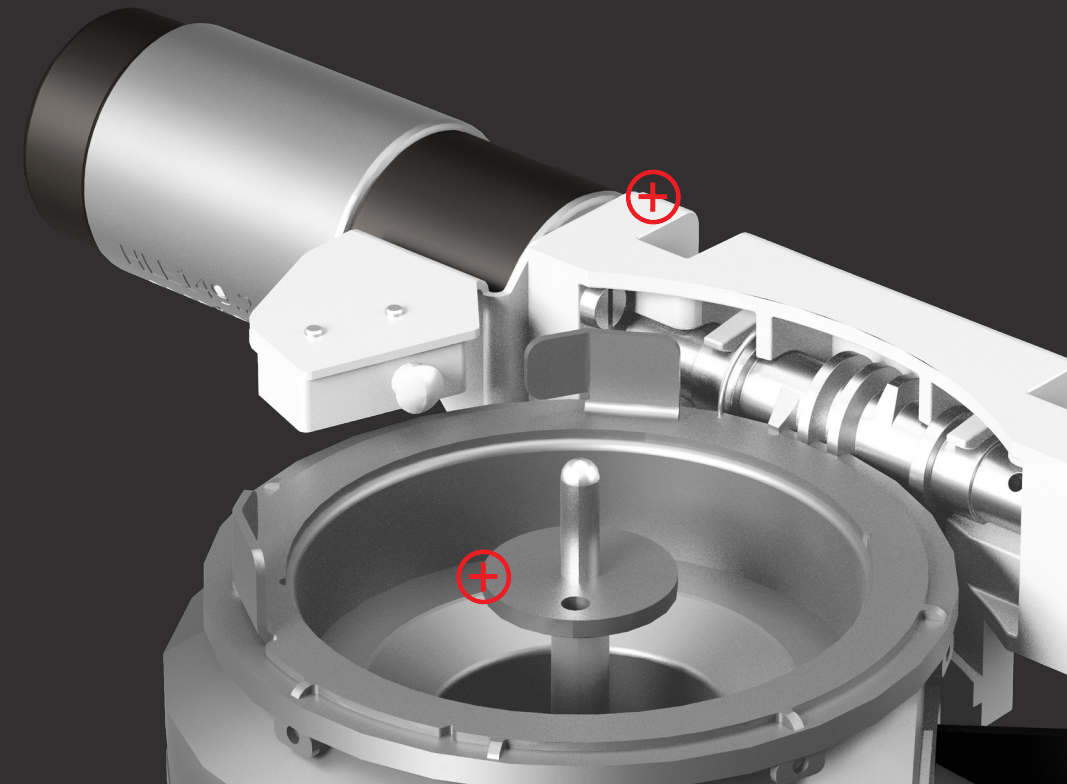

MILK SYSTEMS

Egro Next offers two different systems for the automatic preparation of fresh milk drinks: Quick Milk and NMS+.

QUICK MILK

Quick Milk is the right choice for those who do not have to manage a heavy workflow and want to offer their customers a menu with the great coffee classics such as cappuccino and latte macchiato. Quick Milk is an intuitive milk system that is easy to use and maintain. The Quick Milk system can be used with the Quick Milk fridge or the FUM fridge, both with 4 litres capacity.

LACTOSE-FREE MILK (NMS+ VERSION ONLY)

2 types of milk always at your disposal to work simultaneously with soy milk, oat milk or skimmed milk. And thanks to the system that prevents any type of contamination, you can also offer your customers lactose-free milk, ensuring maximum variety in total safety.

NMS+

NMS+ is Egro's most advanced milk system that guarantees the best results in the cup, especially when preparing milk foam. For each type of drink, it offers the option of adjusting the temperature and frothing level of the milk and choosing between two different types of fresh milk. Designed for locations that require high productivity, NMS+ also offers a more advanced cleaning system that ensures the highest standards of efficiency and hygiene. The NMS+ system requires the installation of the Next fridge (6.5 l), the FUM fridge (4 l) or an external pump module (SMPU) for fridges to be placed under the counter.

COLD MILK FOAM (CMF)

The CMF system (optional) is the solution for automatically preparing cold milk foam for every drink by selecting three different frothing levels via the interface. CMF can only be configured for NMS+ milk system.



FRIDGES



NEXT FRIDGE

6.5 litre fridge with display, level sensor and integrated pump module. On request, the Next fridge is available with the CMF system for cold milk foam. It can also be ordered in a version with two milk containers to work simultaneously with soya, lactose-free or skimmed milk. With the SMPU pump modules, the KS9 can also be installed under the counter to free up space on the worktop.

FUM FRIDGE

4-litre fridge, with pump module and level sensor, which can be placed under the main unit of the machine to optimise worktop space. It is also available in a version with two milk containers and the "lactose-free milk system".

QUICK MILK FRIDGE

Compact 4-litre fridge, easy to install even in space-limited locations.

E SMPU

For the Top Milk and NMS+ versions, a wide range of pump modules is available to install the fridges under the counter.

- Egro Patented Technology



WATER AND STEAM



+ WATER

TEA AND HERBAL INFUSIONS

Different programmable water temperature levels and dosages for tea and other herbal infusions.

WATER WAND

The separate water wand is extendable to suit all the operator's needs and it is possible to deliver water while brewing coffee.

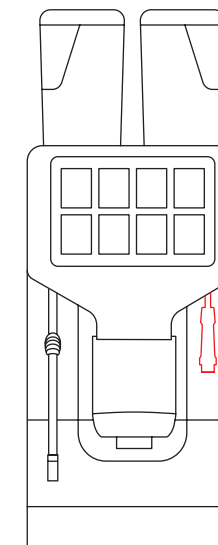

+ STEAM

iSTEAM

iSteam communicates with the touchscreen interface to automatically prepare the milk at the right temperature and froth level mixing steam.

COOL TOUCH STEAM WAND

The cool touch steam wand can be handled in safety and comfort.

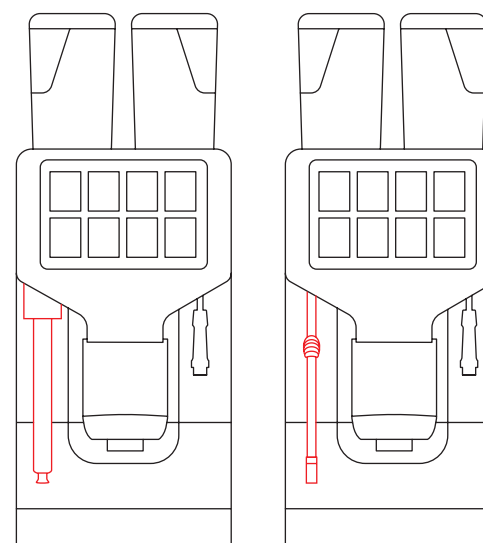

SMART INTERFACE

TOUCHSCREEN INTERFACE

Access, select and adjust settings as easily as you do on your smartphone, thanks to the intuitive 10" HD touchscreen interface.

x10

MENU AVAILABLE
IN 10 LANGUAGES

MULTI-DRINK

Rely on the step-by-step instructions provided by the Multi-Drink software to easily create any recipe you wish in just a few taps. Select your favourite blend or single origin, choose the desired coffee strength, set the pre-infusion time, add the preferred milk or powders.

SELF-SERVICE MODE

Customers can prepare one drink at a time on their own, without the support of the staff.

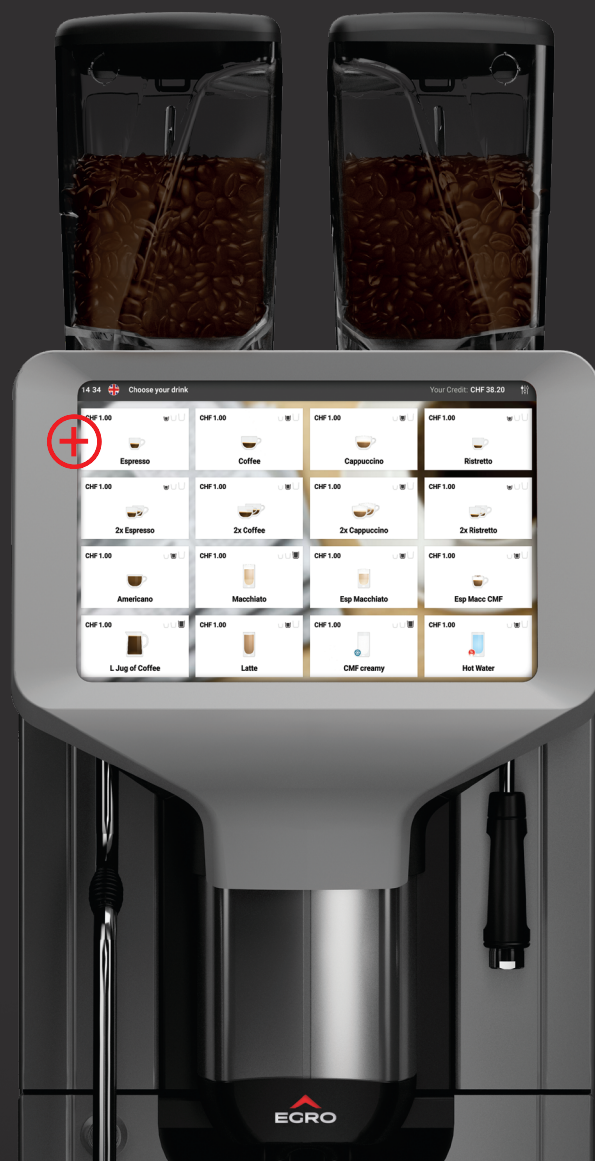

EASY SWITCH

Customise different menus and quickly switch between them to always have the perfect settings for any situation.

THREE ACCESS LEVELS

Egro Next has three dedicated menus to offer the best user experience to baristas, managers and technicians.

QUEUE MODE

The selected items are placed in a queue, possibility for any drink to be brewed earlier or later, to be cancelled or others added.

MULTIMEDIA

Images and promotional videos can be uploaded to personalise the touchscreen, and also be displayed during brewing.

iBUTTON

iButton gives extra information on the product selected as the nutritional value and the origin of coffees.

COUNTERS

Counters are available to display the number of brewed drinks, the income generated, SAG statistics and cleaning settings.

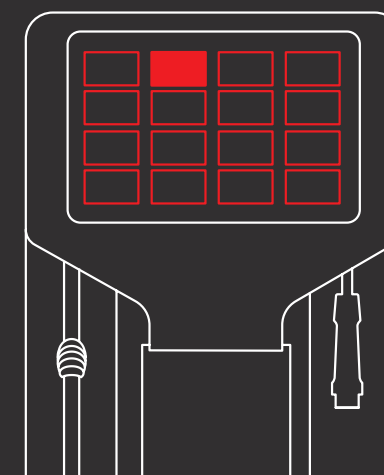

DESIGN AND ERGONOMICS

With its polished stainless steel finish, Egro Next is a stylish, ergonomic, and highly functional machine, with clean, soft lines and scratch-resistant surfaces. The aluminium display frame matches the modern look of the machine.

SPACE SAVING DESIGN

30cm / 12in

MAIN UNIT WIDTH

LED LIGHTS

Maximum visual comfort thanks to LED lights on the work area.

STAINLESS STEEL TRAY

The stainless steel tray is easy to remove and clean. In the self-service version it has two different cup-placing positions, to ensure that any type of cup is always placed correctly under the dispensing spout.

COLOURS

2 colours available for the main unit, fridges and all add-ons:

- INOX/BLACK
- BLACK

AUTOMATIC SPOUT

The Automatic Spout adjusts the height of the dispensing spout to suit the drink selected and fit the type of cup being used. The spout is easy to remove for cleaning.



ADD-ON

BENEFITS

Boost the potential of your Egro Next with add-ons.



EGRO NEXT NMS+

- + NEXT FRIDGE
- + POWDER MODULE
- + CUP WARMER

POWDER MODULE

Offer customers new options by setting up an external Powder Module: select ingredients to automatically mix, prepare and dispense.

2x 1.8 l

POWDER HOPPERS CAPACITY

CUP WARMER

External cup warmer with adjustable temperature level and three heatable trays.

PAYMENT SYSTEMS

Enjoy utmost flexibility with a range of standard and optional payment system solutions.

GUM

External container for coffee grounds to be placed under the machine.

750 g / 1,6 lb

COFFEE GROUNDS
CONTAINER CAPACITY



NEXT X2 NMS+

Next X2 NMS+ is a special configuration that includes two Next NMS+ and a centrally positioned Next refrigerator. It is the ideal solution for all locations that require a high performance level and have to manage peaks of work at several times of the day.

RECOMMENDED
DAILY
OUTPUT

NEXT X2 NMS+

x600

CUPS PER DAY



OTHER CONFIGURATIONS

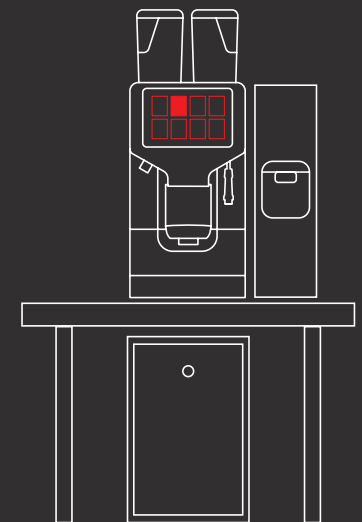
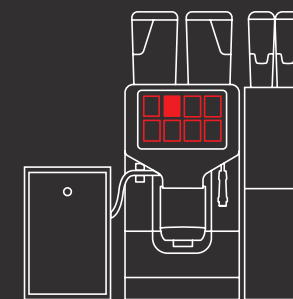
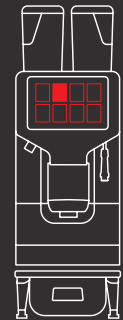
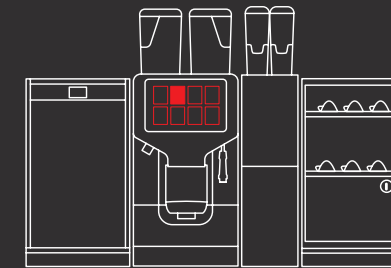
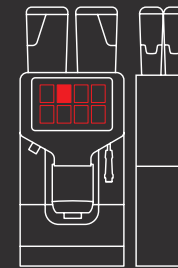

CLEANING AND MAINTENANCE



CLEANING

CLEANING

Fast and simple cleaning makes it easy to uphold high health and hygiene standards.

RINSING CYCLE

A rinsing cycle starts automatically at a preset time after the last beverage delivery.



MAINTENANCE

EASY ACCESS TO ALL COMPONENTS

The convenient opening of the front panel and quick access to the main internal components facilitates easy maintenance operations.



DURA BREW

Dura Brew is a hermetically sealed system requiring little maintenance, and thus reducing the total cost of ownership.

- Egro Patented Technology

USB PORT

Next comes with a USB port to transfer technical data and upload images and videos.

NEXT: TECHNICAL DATA

DIMENSIONS

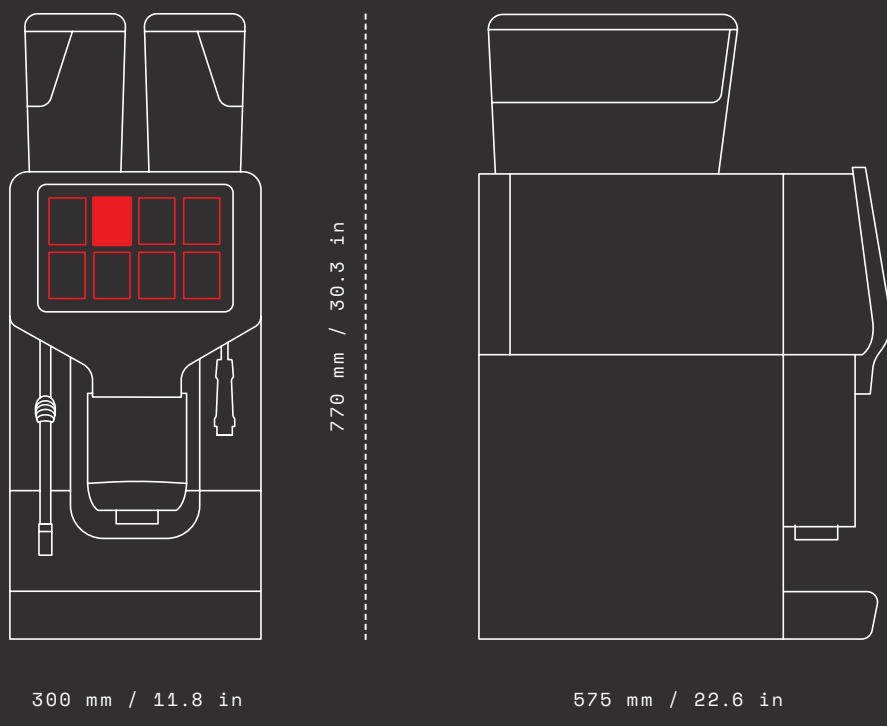

MAIN UNIT: TECHNICAL DATA

W X D X H

300 x 575 x 770 mm
11.8 x 22.6 x 30.3 in

WEIGHT

57 kg / 125.7 lb

POWER SUPPLY

220-240 V3~, 50-60 Hz (6,0 kW)
380-415 V2N~, 50-60 Hz (6,0 kW)
220-240 V~, 50-60 Hz (6,0 kW)
220-240 V~, 50-60 Hz (3,6 kW)
208/240 V2ph~, 60 Hz (5/6 kW)

WATER SUPPLY

Fixed water connection

ENERGY CONSUMPTION PER DAY

Pure Coffee / Quick Milk 1,772 kWh
NMS+ 1,873 kWh

NOISE LEVEL DURING USE

< 70 db

INTERFACE

TOUCH

10" Touchscreen

COLOURS

- INOX/BLACK
- BLACK

RECOMMENDED DAILY OUTPUT

NEXT PURE COFFEE

x250

CUPS PER DAY

NEXT QUICK MILK

x250

CUPS PER DAY

NEXT NMS+

x300

CUPS PER DAY

NEXT

NEXT PURE COFFEE

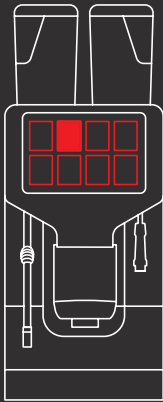

NEXT QUICK MILK

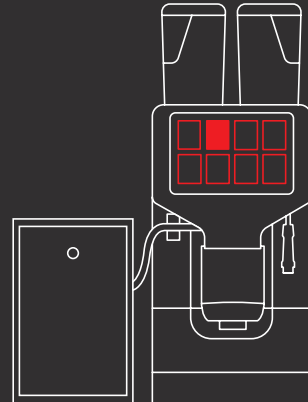

NEXT NMS+

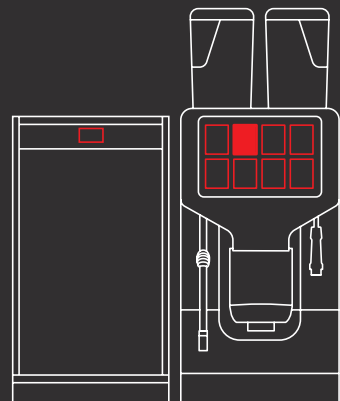

NEXT X2 NMS+

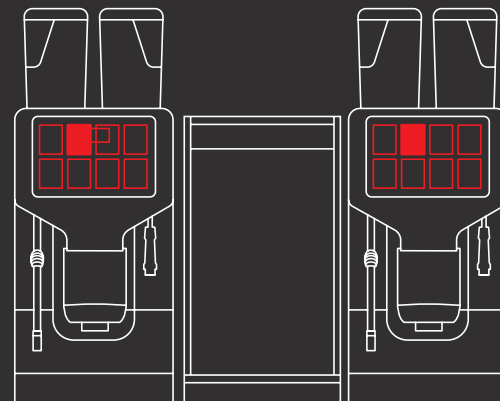

FEATURES

	PURE COFFEE	QUICK MILK	NMS+	X2 NMS+*
COFFEE				
1 Self Adjusting Grinder (SAG)	●	●	●	●
Second Self Adjusting Grinder (SAG)	●	●	●	●
18-g brewing chamber	●	●	●	●
22-g brewing chamber (BC22)	●	●	●	●
Bypass single cup (for 1 cup of caffè Americano)	●	●	●	●
Bypass dual cup (for 2 cups of long coffee)	●	●	●	●
HOT WATER				
central hot water outlet	●	●	●	●
Right side hot water outlet	●	●	●	●
STEAM				
Cool touch steam wand (C-lever system)	●	●	●	●
Automatic steam wand (iSteam)	●	●	●	●
MILK SYSTEMS				
Quick Milk	—	●	—	—
NMS+	—	—	●	●
NMS+ with Cold Milk Foam (CMF)	—	—	●	—
2 types of milk	—	—	●	●
Lactose free milk option	—	—	●	●
FRIDGES				
Next fridge	—	—	●	●
Quick Milk fridge	—	●	—	—
FUM fridge	—	●	●	—
Pump Modules (SMPU)	—	—	●	●
ADDITIONAL OPTIONALS				
Automatic Spout	●	—	●	●
Under counter grounds chute	●	●	●	●
Lock package	●	●	●	●
Option Self (Lock package, Cup stopper)	●	●	●	●
Payment systems	●	●	●	●
Connect (telemetry system)	●	●	●	●
ADD ON				
Powder module	●	●	●	●
Cup Warmer	●	●	●	●
GUM	●	●	●	●

* per machine, excluding fridge

Standard ● Optional ● Not available —

ADD-ONS: TECHNICAL DATA

NEXT FRIDGE

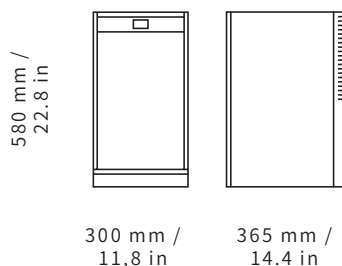

W × D × H
300 × 365 × 580 mm
11.8 × 14.4 × 22.8 in

WEIGHT
29 kg / 63.9 lb

POWER SUPPLY
220–240 V, 50–60 Hz, 0.5 A
China: 220 V, 50 Hz, 0.5 A
120 V, 60 Hz, 1.35 A

MILK CONTAINER CAPACITY
 (1 TYPE OF MILK)
6,5 l / 1,72 gal US / 0,51 gal UK

MILK CONTAINER CAPACITY
 (2 TYPES OF MILK)
2x 3,25 l / 0,71 gal US / 0,51 gal UK

MILK LEVEL SENSOR
Incluso

COLOURS

● INOX ● BLACK

QUICK MILK FRIDGE

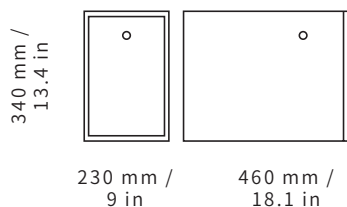

W × D × H
230 × 460 × 340 mm
9 × 18.1 × 13.4 in

WEIGHT
14 kg / 30.1lb

POWER SUPPLY
220 – 240 V~, 50 Hz, 0.62 A
220 V~, 60 Hz, 0.62 A
110 V ~, 60 Hz, 1.35 A

MILK CONTAINER CAPACITY
6,5 l / 1,72 gal US / 0,51 gal UK

COLOURS

● INOX/BLACK ● BLACK

FUM FRIDGE

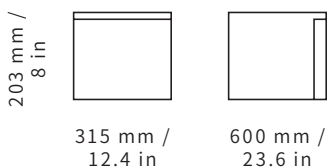

W × D × H
315 × 600 × 203 mm
12.4 × 23.6 × 8 in

WEIGHT
18.5 kg / 40.8 lb

POWER SUPPLY
220 – 240 V~, 50 Hz, 0.8 A
220 V~, 60 Hz, 0.9 A
115 V ~, 60 Hz, 1.3 A

MILK CONTAINER CAPACITY
4 l

COLOURS

● BLACK

POWDER MODULE

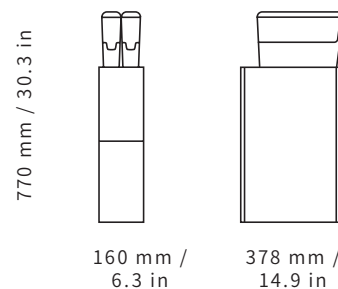

W × D × H
160 × 378 × 770 mm
6.3 × 14.9 × 30.3 in

WEIGHT
13 kg / 28.1lb

POWER SUPPLY
220–240 V~, 50–60 Hz
120 V~, 60 Hz

POWER RATING
0.1 kW

POWDER HOPPER CAPACITY
2x 1.8 l

COLOURS
 ● INOX/BLACK ● BLACK

CUP WARMER

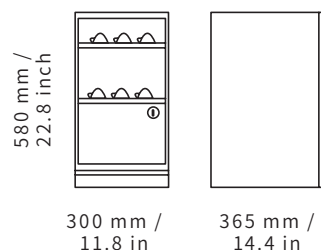

W × D × H
300×365×580 mm
11.8×14.4×22.8 inch

WEIGHT
14 kg / 30.1lb

POWER SUPPLY
220–240 V~, 50 Hz

POWER RATING
420 W

COLOURS
 ● INOX/BLACK ● BLACK

PAYMENT SYSTEMS

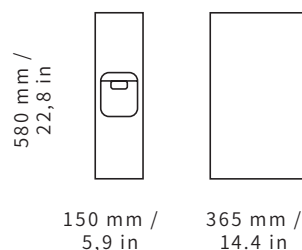

W × D × H
150 × 365 × 580 mm
5.9 × 14.4 × 22.8 in

POWER SUPPLY
24 V from coffee machine

COLOURS
 ● INOX/BLACK ● BLACK

GUM

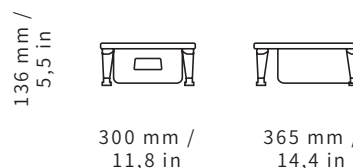

W × D × H
300 × 365 × 136 mm
11.8 × 14.4 × 5.5in

COFFEE GROUNDS CONTAINER CAPACITY
750 g

POWER SUPPLY
24 V from coffee machine

COLOURS
 ● INOX

CONNECT

POWER TO YOUR COFFEE BUSINESS

It doesn't matter what size your organization is, the only important thing is that you want to improve your coffee business. Connect helps you to make effective use of the data generated by your coffee machines, and support you in advancing your own journey becoming a data-driven business. It's time to take a competitive advantage in whatever marketplace you operate in.

RANCILIOGROUP.COM/CONNECT

BENEFITS

 **1**
USER-FRIENDLY DASHBOARD

 **2**
MANAGE YOUR FLEET WITH EASE

 **3**
BOOST SERVICE EFFICIENCY

 **4**
INCREASE BUSINESS PERFORMANCE

HOW IT WORKS

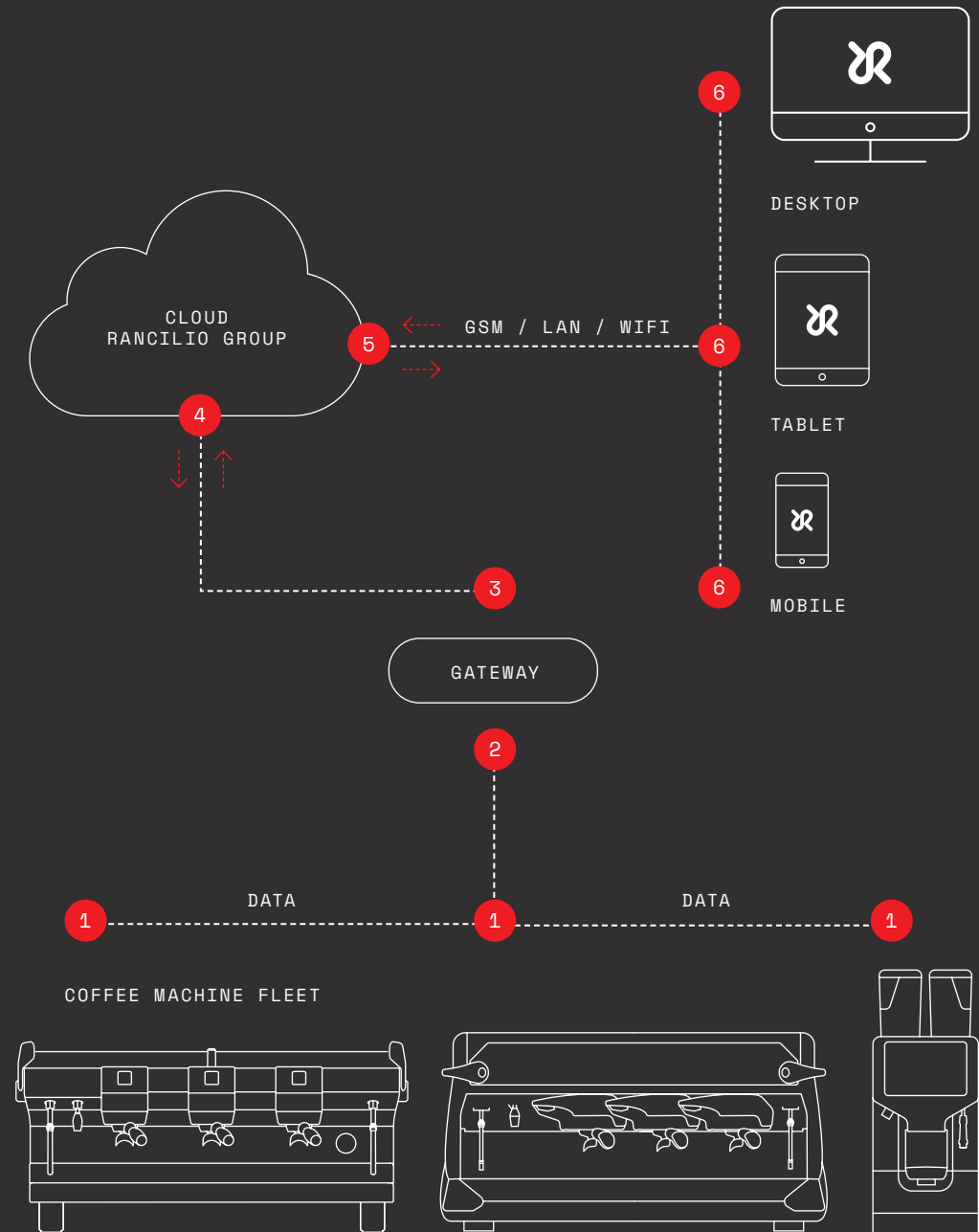

 **RANCILIO** GROUP

ranciogroup.com



an Ali Group company



The Spirit of Excellence